

# ŽUMPA - 7 m<sup>3</sup>

PŮDORYS M1:25

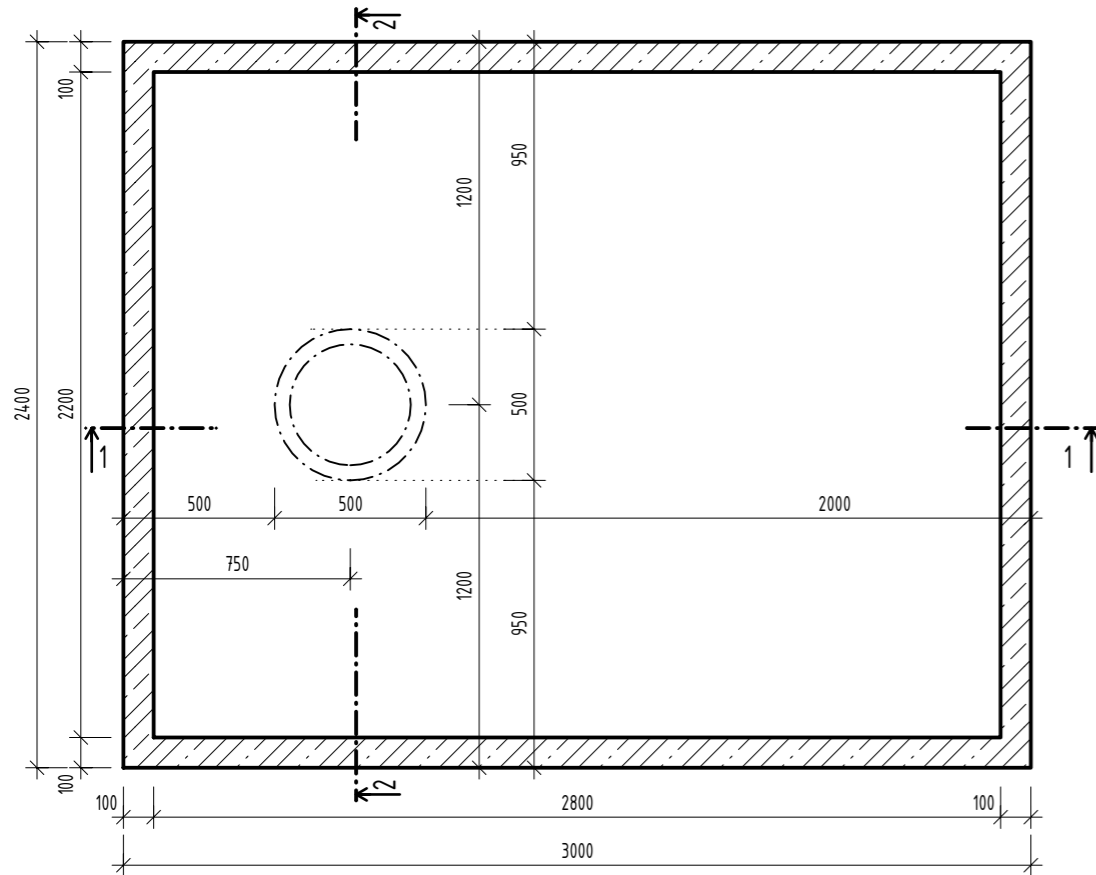

REZ 1-1 M1:25

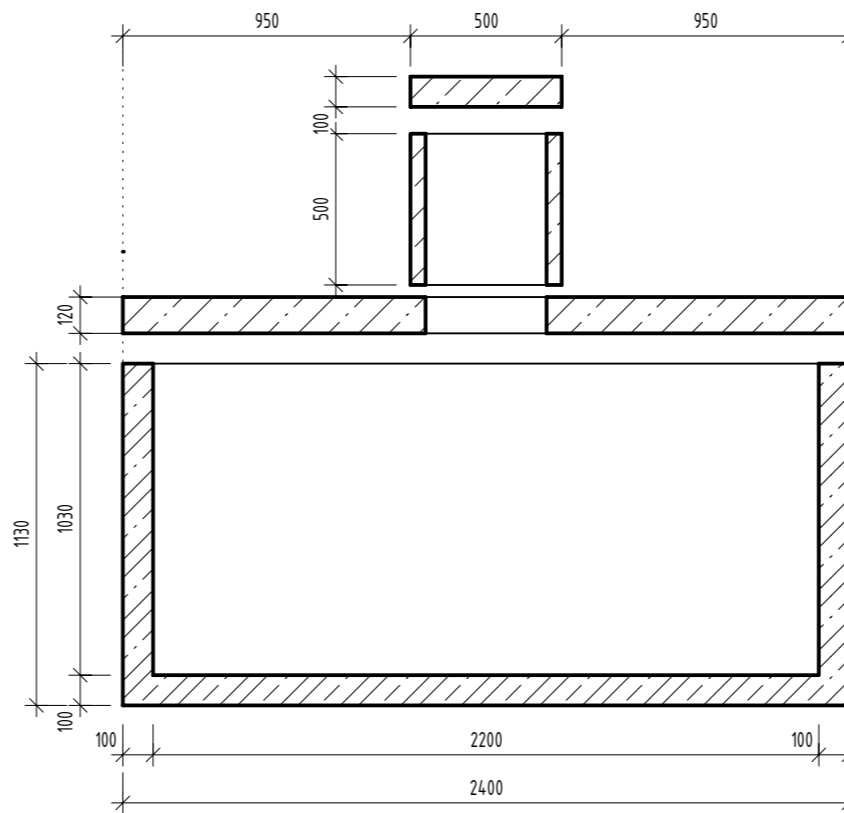
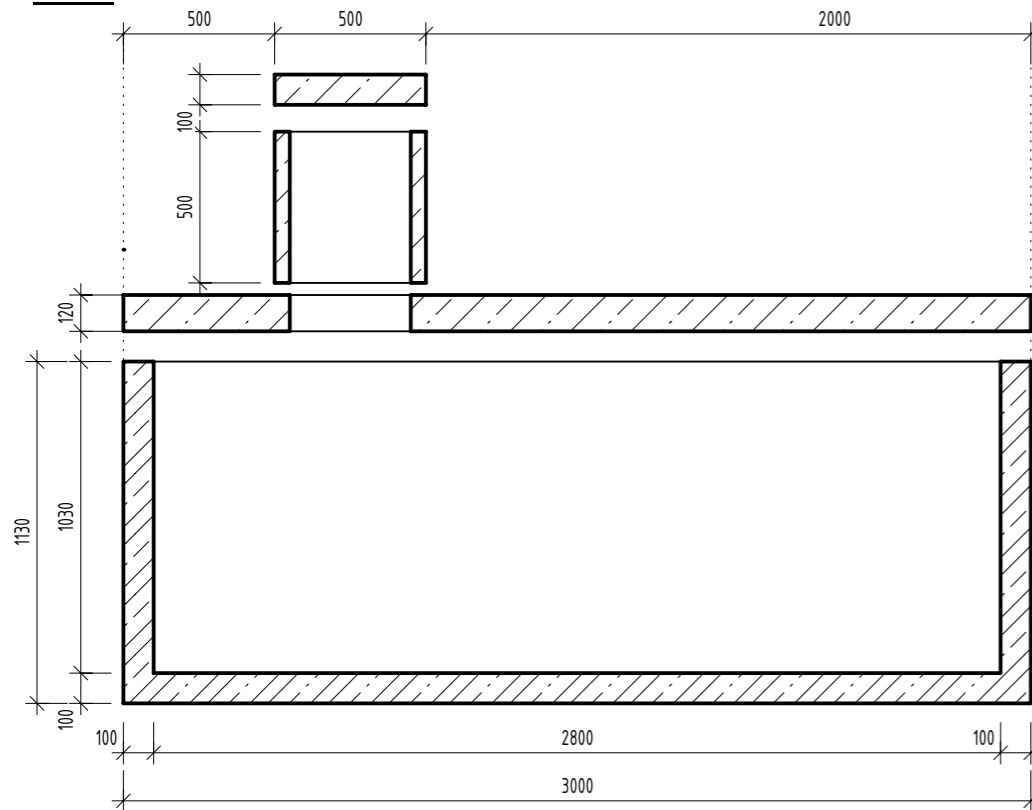

TECHNICKÉ PARAMETRE :

OBJEM: 7,0 m<sup>3</sup>

MATERIÁL: VODOSTAVEBNÝ ARMOVANÝ BETÓN

ROZMERY: dlxšxv: 3,0 x 2,4 x 1,25 m

HRŮBKA POKLOPU DOSKY: 0,12 m

